

# Standard specifications

MX700NFE04001

April 27, 2015

KAWASAKI HEAVY INDUSTRIES, LTD.

ROBOT DIVISION

Specification :	90101-2348DEA
(Arm) :	90151-0063DEA
(Controller) :	90152-0015DEA

# 1. Specification of Robot

## [1] Robot Arm

1. Model	MX700N-D														
2. Type	Articulated robot														
3. Degree of freedom	6 axes (Option 7 axes)														
4. Axis specification	Operating axis	Max. operating range	Max. speed												
	Arm rotation (JT1)	+180° ~ -180°	65°/s												
	Arm out-in (JT2)	+90° ~ -45°	50°/s												
	Arm up-down (JT3)	+20° ~ -130°	45°/s												
	Wrist swivel (JT4)	+360° ~ -360°	50°/s												
	Wrist bend (JT5)	+110° ~ -110°	50°/s												
	Wrist twist (JT6)	+360° ~ -360°	95°/s												
	Linear traverse ( - )	2000 mm (Standard)	1000 mm/s												
5. Repeatability	±0.5 mm (at the tool mounting surface)														
6. Max. payload	700 kg														
7. Max. linear interpolation speed	2000 mm/s														
8. Load capacity of wrist	<table border="1"> <thead> <tr> <th></th> <th>Max. torque</th> <th>Moment of inertia*</th> </tr> </thead> <tbody> <tr> <td>JT4</td> <td>5488 N·m</td> <td>600 kg·m<sup>2</sup></td> </tr> <tr> <td>JT5</td> <td>5488 N·m</td> <td>600 kg·m<sup>2</sup></td> </tr> <tr> <td>JT6</td> <td>2744 N·m</td> <td>388 kg·m<sup>2</sup></td> </tr> </tbody> </table>				Max. torque	Moment of inertia*	JT4	5488 N·m	600 kg·m <sup>2</sup>	JT5	5488 N·m	600 kg·m <sup>2</sup>	JT6	2744 N·m	388 kg·m <sup>2</sup>
		Max. torque	Moment of inertia*												
JT4	5488 N·m	600 kg·m <sup>2</sup>													
JT5	5488 N·m	600 kg·m <sup>2</sup>													
JT6	2744 N·m	388 kg·m <sup>2</sup>													
	<p>Note* Each value in this table shows allowable moment of inertia of JT4/JT5/JT6 when max. allowed torque is applied to each axis. If more detailed data is required for your application, please contact Kawasaki.</p>														
9. Driving motor	Brushless AC Servomotor														
10. Working range	See attached drawing.														
11. Mass	2860 kg (without options)														
12. Color	Munsell 10GY9/1 equivalent														
13. Installation	Floor mounting														
14. Built-in utilities	Pneumatic piping ( φ 12×2lines)														
	Wirings for valves to operate the hand (DC24 V × 7 circuits)														
15. Environment cond.	(Temperature) 0 ~ 45 °C, (Humidity) 35 ~ 85 %, no dew, nor frost allowed														
16. Options	Color	Color (Munsell )													
	Mechanical stopper	JT1, JT2, JT3													
	Limit switch	JT1, JT2, JT3													
	Solenoid valves	Double solenoid valve×2 Double solenoid valve×3													
	Optional harness	Type C0, Type H0(NPN), Type H0(PNP), Type E0(NPN), Type E0(PNP)													
	Servo on lamp	Comply UL Standard													
	Jig for conveyance	Fork pockets													
17. Others	Consult Kawasaki about maintenance parts and spare parts.														

[2] Controller		
1. Model	E04	
2. Enclosure	Enclosed structure / Indirect cooling system	
3. Dimensions	See attached drawing	
4. Number of controlled axes	Max.8 axes (standard 6 axes, option 2 axis)	
5. Servo control and drive system	Full Digital Servo System	
6. Type of control	Teach mode	Joint, Base, Tool, Fixed Tool (option) operation mode
	Repeat mode	Joint, Linear, Circular (option) interpolation
7. Teaching method	Teaching or AS language programming	
8. Memory capacity	8 MB	
9. External operation signals	External Emergency stop, External Hold, etc.	
10. Number of IO slots	3 slots	
11. Operation panel	Teach/Repeat SW, Emergency Stop SW, Control power lamp	
12. Communication I/F	Ethernet(100BASE-TX) , USB, RS-232C each 2port (1port on panel, 1port inside controller)	
13. Mass	See attached drawing	
14. Power requirement	AC200 V - AC220 V $\pm$ 10%, 50/60 Hz, 3 phases, Max. 12 kVA	
15. Ground	Less than 100 $\Omega$ (robot dedicated ground) Leakage current: max. 100 mA	
16. Ambient temperature	0 - 45°C	
17. Relative humidity	35 - 85 % (non-condensation)	
18. Color	Munsell: 10GY9/1 equivalent	
19. Teach Pendant	TFT color display (5.7 inch LCD) with touch panel Emergency Stop SW, Teach Lock SW and Enable SW	
20. Safety Circuit	Category: 4, Performance Level: e (EN ISO13849-1) ★	
21. Standard Options		
General purpose IO board	IN:32 OUT:32 NPN(sink) type or PNP(source) type	
TP sheet language	English or Japanese or Chinese	
I/O connector	D-SUB 37pin(male, female) with cover	
Power/Signal cable	5m, 10m, 15m	
Teach Pendant cable	5m, 10m, 15m	
Transformer unit	AC380V-415V / AC440V-480V by tap selection	
22. Other Options		
Additional IO board	IN:64/96 OUT:64/96 NPN(sink) type or PNP(source) type	
Motor brake release	Manual brake release switch BOX	
PC cable (RS-232C)	1.5 m, 3 m	
External axes control	Additional amplifier for external axis	
Extended safety functions	Cubic-S(Motion area monitoring, Joint monitoring, Speed monitoring etc.)	
Teach Pendant option	Connector for TP less	
Fast check mode	Fast check mode Switch	
Others	Field BUS, Software PLC, Analog input/output, Conveyor Synchronization	
23. Others	Consult Kawasaki about maintenance parts and spare parts.	

★ Category and Performance level (PL) are determined by the whole system and conditions.  
The safety circuit of this controller is available in the system of category: up to 4, PL: up to e.

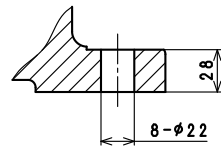
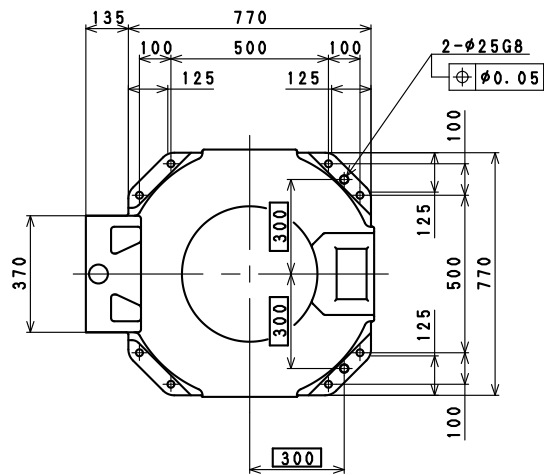

Installation Dimensions

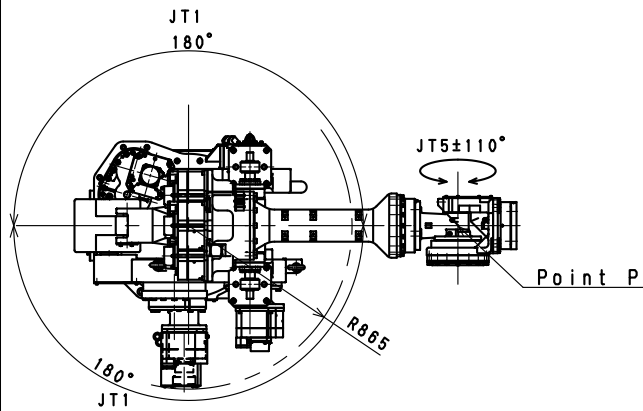

Working range based on point P

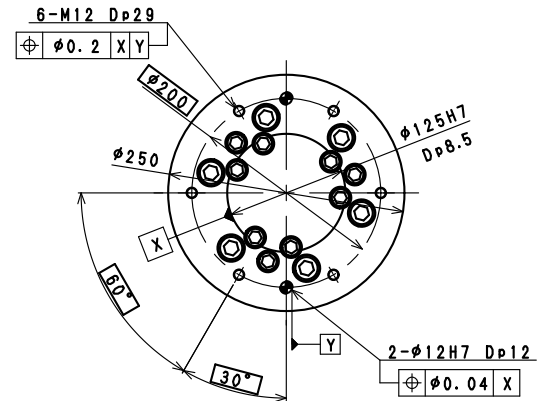
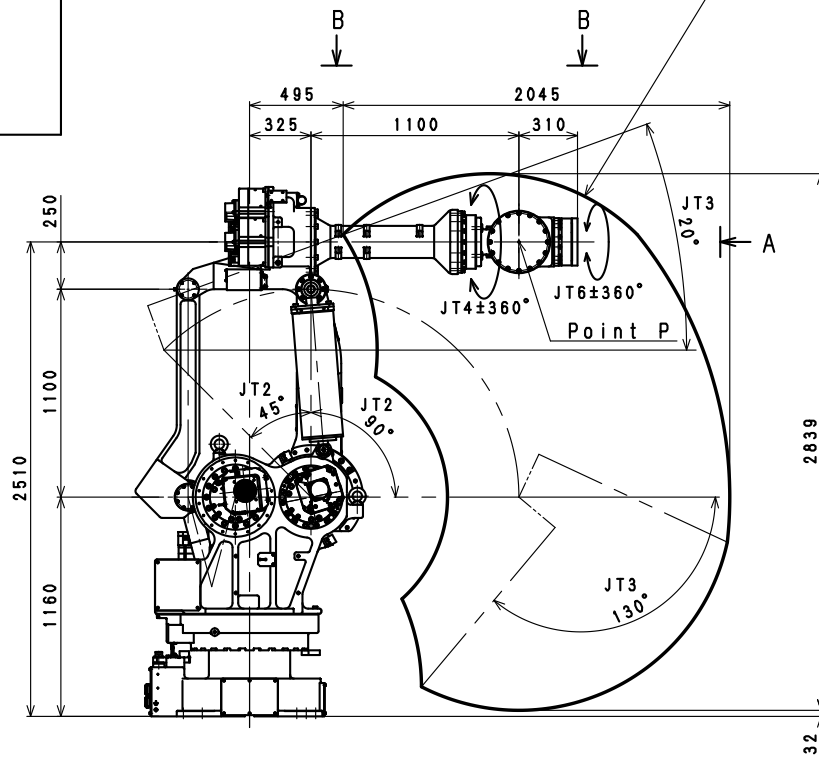

View A

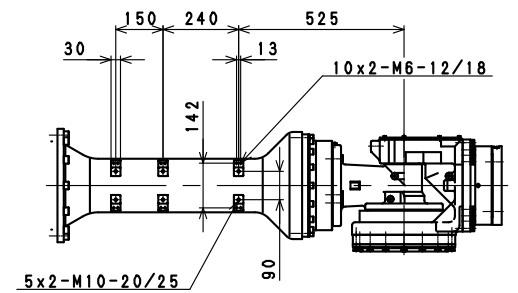

View B-B

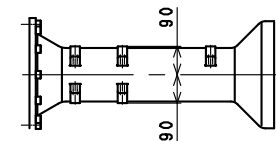

View C-C

MX700N  
WORKING RANGE

E 0 4   C O N T R O L L E R

M A S S : 4 0 K g

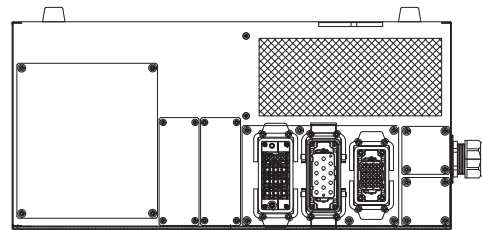

R E A R   V I E W

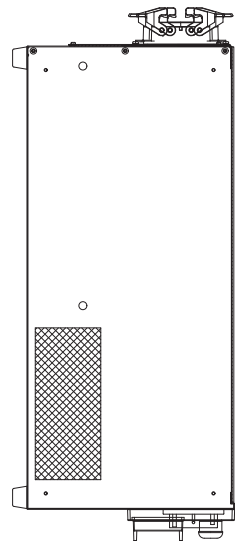

S I D E   V I E W

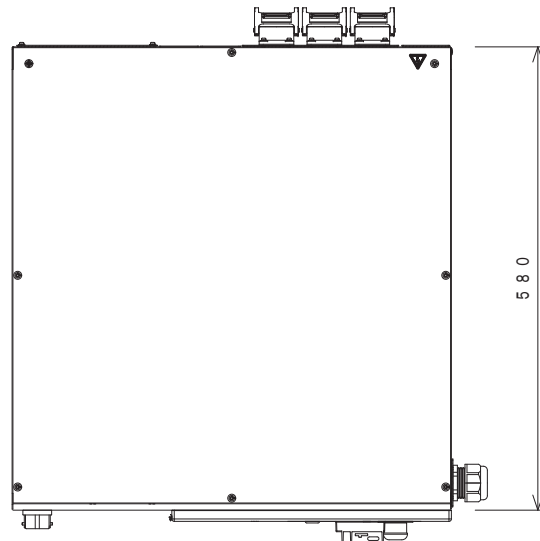

T O P   V I E W

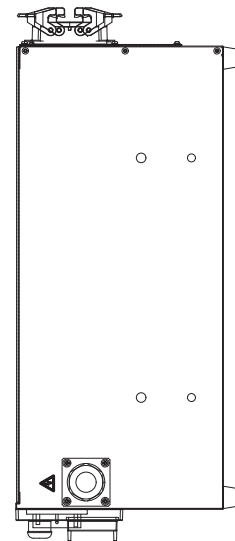

S I D E   V I E W

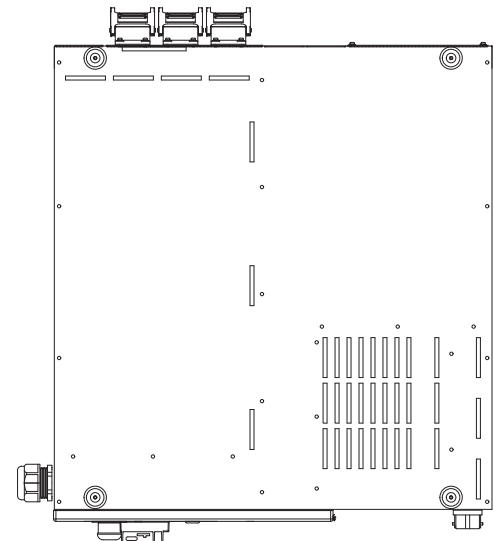

B O T T O M   V I E W

V e r t i c a l   M o u n t

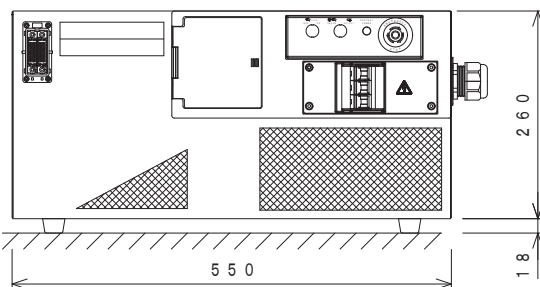
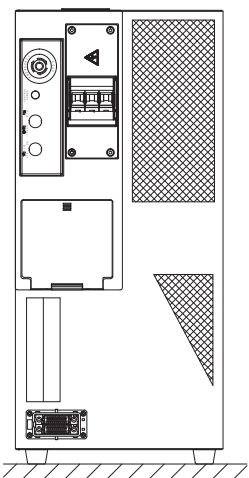

F R O N T   V I E W

